

W254 + T355 + B380

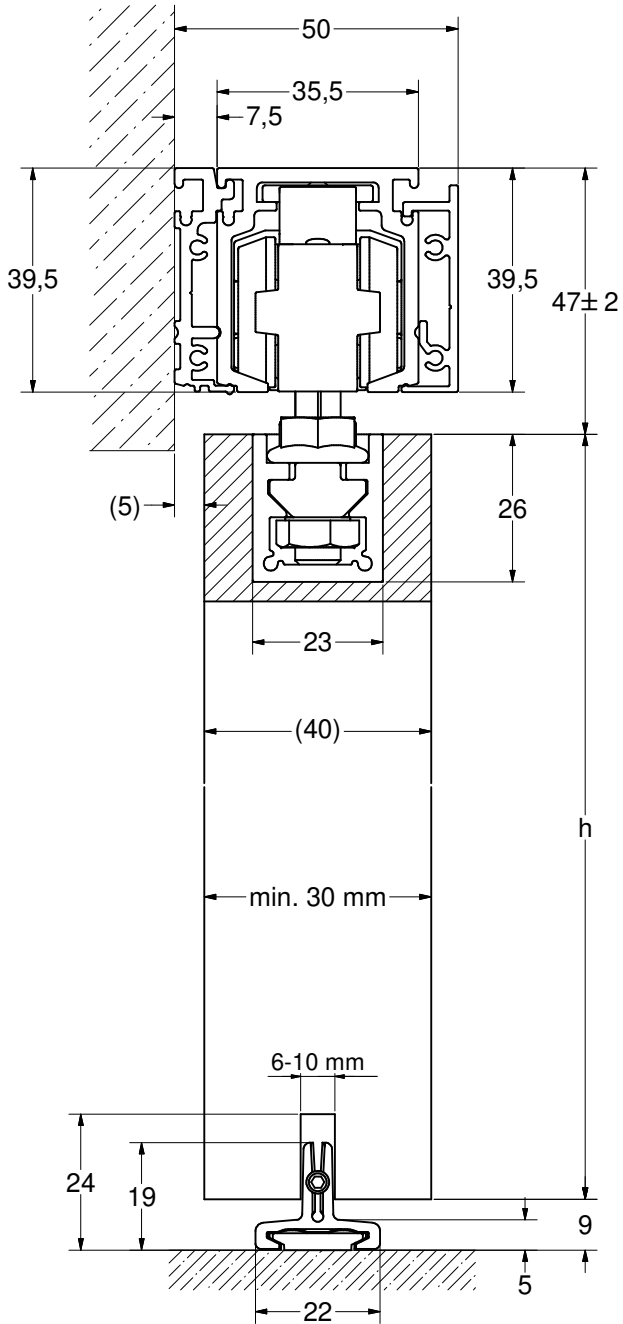

W255 + T355 + B380

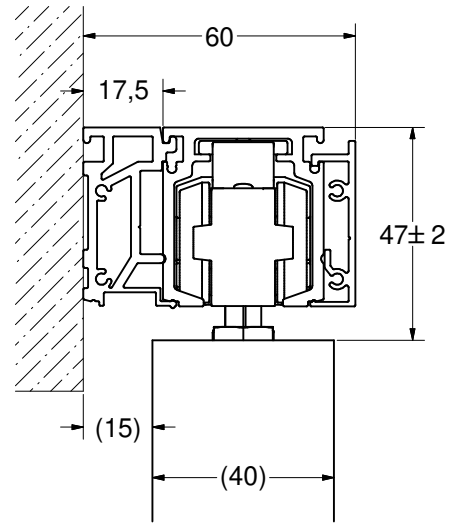

W215 + T355 + B380

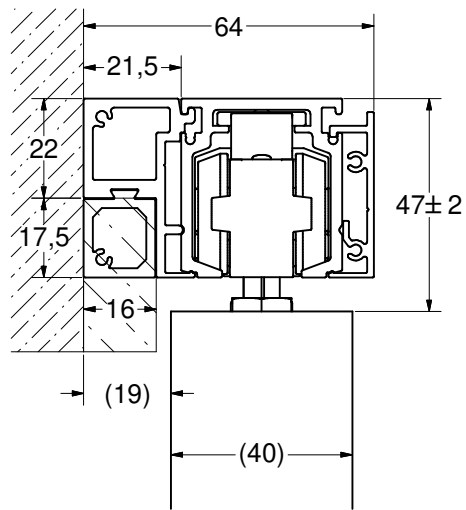

B380 + T355 + B380

